

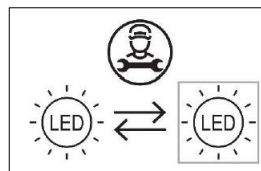

0688

FLOODLIGHTS



WARNING

ANY MODIFICATION TO THIS FITTING IS FORBIDDEN WITHOUT PRIOR AUTHORIZATION

Our policy is the constant improvement of the product. We reserve the right to modify the characteristics of the equipment without prior notice. Please refer to the website www.arcluce.it for this and other technical documents continually updated.

All information is presented in good faith. no responsibility may be imputed to us for errors, omissions or incorrect interpretations.

The photographs and drawings are within the limits of the quality of the printed reproduction, not binding and indicative only.



Directive 2002/96/CE (Waste Electrical and Electronic Equipment - WEEE). The crossed out wheeled bin label that this product should not be disposed how the normal household waste stream, but with a separate collection; this in order to prevent potential negative consequences for the environment and the human health. For more details on available collection facilities please contact your local government office or the dealer where you purchased this product.

The safety and the proper functioning of the fitting is guaranteed only respecting the electrical Standards and these mounting instructions; therefore it's necessary to keep them.

Installation should be carried out by a suitable qualified person. Always refer to electrical data on the fixture label.

The light source contained in this luminaire shall only be replaced by the manufacturer or his service agent or a similar qualified person. Only use original ARCLUCE spare parts.



Turn off power before maintenance (1)

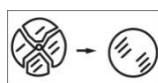

Replace any cracked shield (2).



Risk group 1 (IEC/TR62778). Do not stare at operating LED (3).

SPECIFICATIONS

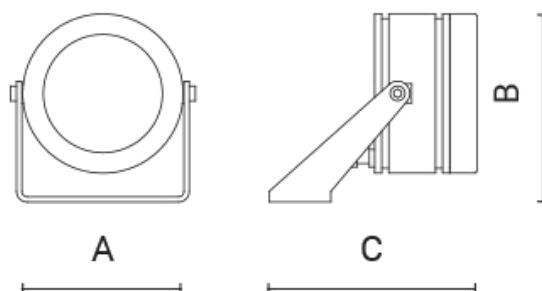

MECHANICAL

Dimensions: A: 91 mm
B: 108 mm
C: 118 mm

Weight: 1,9 Kg

Rated Ta: -20°C ÷ +25°C

ELECTRICAL

Wiring: REM-D

Input: WHITE: 350 mA
RGBW: 4x350 mA
CONSTANT CURRENT

ACCESSORIES

1099329X

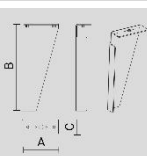

AISI 316L
stainless steel
peg.

1099257X

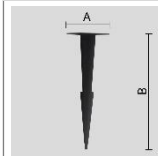

Thermoplastic
material peg.

1099375X



AISI 316L
stainless-steel
sloped visor.

1099341X
1099348X



Honeycomb
louvre.
1099341X or
1099348X.
See catalog for
details.

1099408X



Linear connector
IP68 - 2 poles

1099259X



Distribution box
IP68 - 2/3 poles

INSTALLATION

1. Secure bracket to supporting surface using only screws and dowels suitable for the mounting surface (by others)
2. Wire the fixture according to diagram.
3. Adjust orientation.

1

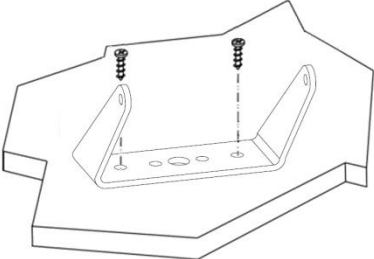

Use only screws and dowels suitable for the mounting surface (by others) (1).

Care must be taken in the installation. This is not a heavy duty luminaire (2).

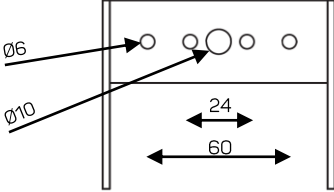

3

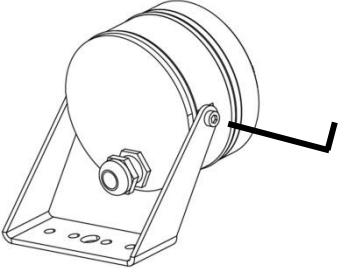

Loosen screw to adjust and tight back again when done (1).

2

- Turn off power (1).
- Connect the fixture to the driver before supplying the power (2).
- Connect only to SELV drivers (3).
- The cable connection must have an IP rating at least equal or higher than the fixture itself (4).
- If the external flexible cable or cord of this luminaire is damaged, it shall be exclusively replaced by the manufacturer or his service agent or a similar qualified person in order to avoid a hazard (5).

WHITE

+LED - BROWN

-LED - BLUE

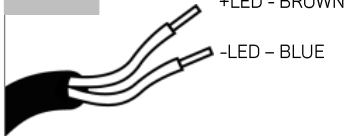

RGBW

RED - LED RED+

BLACK/RED - LED RED-

ORANGE - LED GREEN+

BLACK/ORANGE - LED GREEN-

WHITE - LED WHITE+

BLACK/WHITE - LED WHITE-

BLUE - LED BLUE+

BLACK/BLUE - LED BLUE-

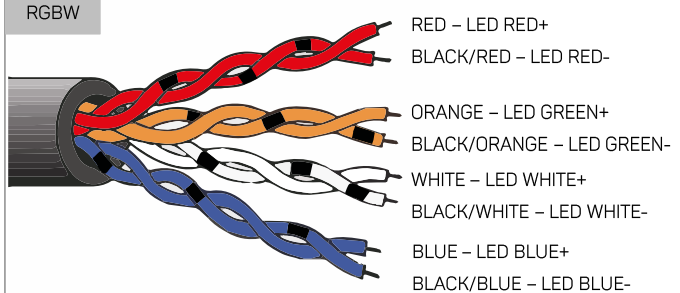

REM-D versions: This is a constant current fixture. It requires a series connection of fixtures to the driver (6).

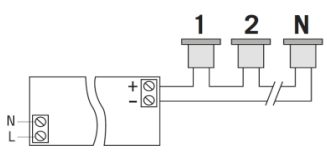

1099408X or 1099257X

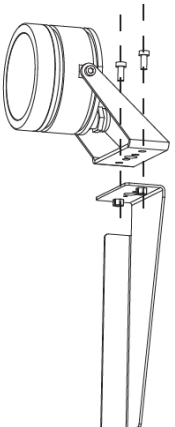

1099375X

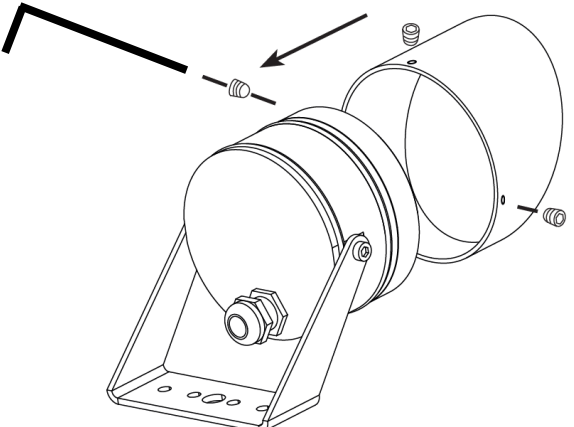



For applications with $T_a > 25^\circ\text{C}$ do respect the following time schedule (2).

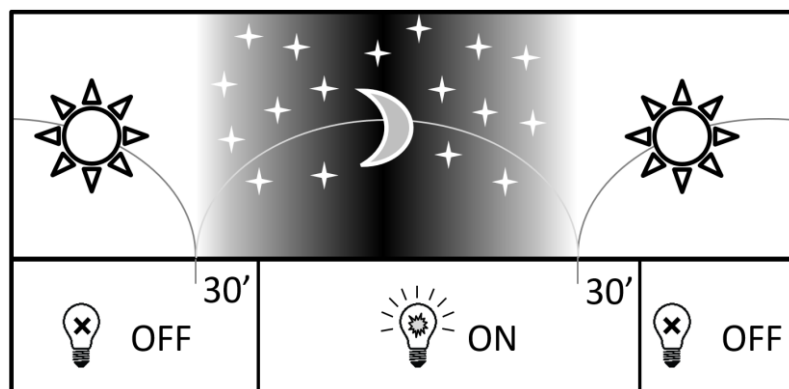

AVVERTISSEMENTS

TOUTE MODIFICATION DE CET APPAREIL, SANS AUTORISATION, EST INTERDITE

Notre politique est l'amélioration constante du produit. Nous nous réservons le droit de modifier les caractéristiques de l'équipement sans préavis. Veuillez-vous référer au site web www.arcluce.it pour cela et d'autres documents techniques continuellement mis à jour. Toutes les informations sont présentées de bonne foi, aucune responsabilité ne peut nous être imputée pour des erreurs, des omissions ou des interprétations incorrectes. Les photographies et les dessins sont dans les limites de la qualité de la reproduction imprimée, ils ne sont pas contraignants et à titre indicatif seulement.

Directive 2002/96/CE (Déchets d'Équipements Électriques et Électroniques - DEEE). L'étiquette de la poubelle à roulettes barrée indique que ce produit ne doit pas être éliminé comme les déchets urbains mais par une collecte séparée; ceci afin d'éviter des conséquences négatives potentielles sur l'environnement et la santé humaine. Pour plus de détails sur les installations de collecte disponibles, veuillez contacter votre administration locale ou le revendeur auprès duquel ce produit a été acheté.

La sécurité et le bon fonctionnement du luminaire sont garantis uniquement en respectant les normes électriques et les présentes instructions de montage; donc il est nécessaire de les garder. L'installation doit être effectuée par une personne qualifiée appropriée. Toujours se référer aux données électriques sur l'étiquette du luminaire la source lumineuse contenue dans ce luminaire ne doit être remplacée que par le fabricant, son agent de service ou une personne qualifiée similaire. N'utilisez que des pièces de rechange ARCLUCE.

(1) Avant toute intervention sur l'appareil éteindre l'alimentation. (2) Remplacez tout bouclier fissuré. (3) Groupe à risque 1 (IEC/TR62778). Ne pas fixer la DEL en fonctionnement.

INSTALLATION:

1. Fixer le support à la surface de support en utilisant uniquement des vis et des chevilles adaptées à la surface de montage (par des tiers).
2. Câbler le luminaire selon le schéma.
3. Ajuster l'orientation.

IMAGES:

(1.1) Utilisez uniquement des vis et des chevilles adaptées à la surface de montage (par d'autres). (1.2) Des précautions doivent être prises lors de l'installation. Ce n'est pas un luminaire pour applications lourdes. (2.1) Éteindre l'alimentation. (2.2) Connectez l'appareil au driver avant de le mettre sous tension. (2.3) Connectez seulement à des driver SELV. (2.4) La connexion du câble doit avoir un indice IP au moins égal ou supérieur à celui de l'appareil lui-même. (2.5) Si le câble flexible externe ou le câble de ce luminaire sont endommagés, il doit être remplacé exclusivement par le fabricant, son agent de service ou une personne qualifiée similaire, afin d'éviter tout risque. (2.6) Versions REM-D : il s'agit d'un luminaire à courant constant. Il nécessite une connexion en série des luminaires au driver. (3.1) Desserrez la vis pour ajuster et resserrez en suite. (3.2) Pour les applications avec $T_a > 25^\circ\text{C}$, respectez les plages horaires suivantes.

AVVERTENZE

SONO VIETATE MODIFICHE ALL'APPARECCHIO SENZA AUTORIZZAZIONE

Perseguiamo una politica di costante miglioramento del prodotto. Ci riserviamo il diritto di modificare le caratteristiche dell'apparecchiatura senza preavviso. Si prega di fare riferimento al sito www.arcluce.it per questo e altri documenti tecnici che vengono continuamente aggiornati. Tutte le informazioni sono presentate in buona fede. Nessuna responsabilità ci può essere attribuita per errori, omissioni o interpretazioni errate. Le fotografie e i disegni sono nei limiti della qualità della riproduzione stampata, non sono vincolanti e solo per informazione.

Direttiva 2002/96/CE (Rifiuti di Apparecchiature Elettriche ed Elettroniche - RAEE). Il pittogramma del bidone con ruote barrato indica che questo prodotto non deve essere smaltito come normale rifiuto urbano ma attraverso raccolta separata; questo per evitare potenziali conseguenze negative per l'ambiente e la salute umana. Per i dettagli sulle strutture di raccolta disponibili, contattare l'ufficio governativo locale o il rivenditore presso il quale è stato acquistato il prodotto.

La sicurezza e il corretto funzionamento dell'apparecchio sono garantiti solo rispettando le normative elettriche e queste istruzioni pertanto è necessario conservarle.

L'installazione deve essere eseguita da personale qualificato fare sempre riferimento ai dati elettrici presenti sull'etichetta dell'apparecchio. La sorgente luminosa contenuta in questo apparecchio deve essere sostituita solo dal costruttore o dal suo servizio di assistenza o da personale altrettanto qualificato. Utilizzare solamente pezzi di ricambio originali ARCLUCE.

(1) Prima di qualsiasi intervento sul dispositivo, spegnere l'alimentazione. (2) Sostituire gli schermi di protezione danneggiati. (3) Gruppo di rischio 1 (IEC/TR62778). Non fissare il LED durante il suo funzionamento.

INSTALLAZIONE

1. Fissare la staffa alla superficie di supporto utilizzando solo viti e tasselli adatti alla superficie di montaggio (non forniti).
2. Cablare l'apparecchio seguendo lo schema.
3. Regolare l'orientamento.

IMMAGINI

(1.1) Utilizzare solo viti e tasselli adatti alla superficie di montaggio (non forniti). (1.2) Si deve prestare la massima attenzione durante l'installazione. Questo non è un apparecchio a uso gravoso. (2.1) Spegner l'alimentazione. (2.2) Collegare l'apparecchio al driver prima di collegare l'alimentazione. (2.3) Collegare solo a dei driver SELV. (2.4) La connessione del cavo deve avere un grado IP almeno uguale o superiore a quello dell'apparecchio stesso. (2.5) Se il cavo flessibile esterno o il cavo di questo apparecchio è danneggiato, deve essere sostituito esclusivamente dal produttore o dal suo agente di assistenza o da una persona ugualmente qualificata per evitare rischi. (2.6) Versioni REM-D: questo è un dispositivo a corrente costante. Richiede una connessione in serie degli apparecchi al driver. (3.1) Allentare la vite per regolare e stringere di nuovo una volta terminato. (3.2) Per applicazioni con $T_a > 25^\circ\text{C}$ rispettare le seguenti fasce orarie d'accensione.