

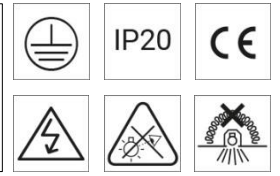

## 0111

### MODULAR SYSTEM

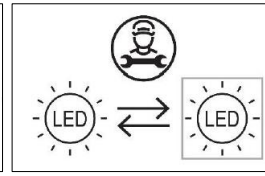
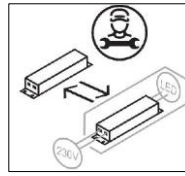

#### WARNING

**ANY MODIFICATION TO THIS FITTING IS FORBIDDEN WITHOUT PRIOR AUTHORIZATION**

Our policy is the constant improvement of the product. We reserve the right to modify the characteristics of the equipment without prior notice. Please refer to the website [www.arcluce.it](http://www.arcluce.it) for this and other technical documents continually updated.

All information is presented in good faith. no responsibility may be imputed to us for errors, omissions or incorrect interpretations.

The photographs and drawings are within the limits of the quality of the printed reproduction, not binding and indicative only.



Directive 2002/96/CE (Waste Electrical and Electronic Equipment - WEEE). The crossed out wheeled bin label that this product should not be disposed how the normal household waste stream, but with a separate collection; this in order to prevent potential negative consequences for the environment and the human health. For more details on available collection facilities please contact your local government office or the dealer where you purchased this product.

The safety and the proper functioning of the fitting is guaranteed only respecting the electrical Standards and these mounting instructions; therefore it's necessary to keep them.

Installation should be carried out by a suitable qualified person. Always refer to electrical data on the fixture label.

The light source contained in this luminaire shall only be replaced by the manufacturer or his service agent or a similar qualified person. Only use original ARCLUCE spare parts.



Turn off power before maintenance (1)



Luminaires not suitable for covering with thermally insulating material (3)



Risk group 1 (IEC/TR62778). Do not stare at operating LED (2)

## SPECIFICATIONS





#### MECHANICAL

Dimensions:	A: 52 mm
	B: 110 mm
	C: 1123 / 1403 / 2246 / 2806 mm
Weight:	DIRECT: 2.7 Kg / 3.3 Kg / 4.8 Kg / 5.8 Kg
	DIRECT/INDIRECT: 3.5 Kg / 4.2 Kg / 5.9 Kg / 7.3 Kg
Rated Ta:	-20°C ÷ +25°C

#### ELECTRICAL

Wiring:	ON/OFF, DALI, PUSH, EM
Input:	220-240V 50/60Hz
Electrical insulation class	I

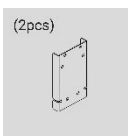
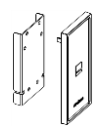
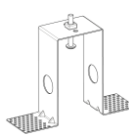
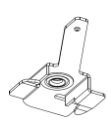
## ACCESSORIES

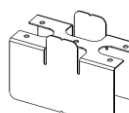
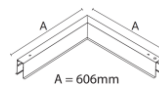
<p><b>1099509X</b></p>  <p>(2pcs) Painted steel end caps for trimless recessed installation (2 pcs)</p>	<p><b>1099230X</b></p>  <p>Painted die-cast aluminum end caps for direct/indirect and ceiling mount versions (2 pcs)</p>	<p><b>1099511X</b></p>  <p>Mounting brackets in galvanized steel for installation in plasterboard ceilings (2 pcs). It does not require over plastering.</p>	<p><b>1099380X</b></p>  <p>Galvanized steel ceiling installation bracket (2 pcs).</p>
 <p><b>1099180X</b> Direct /Indirect light steel cable (1.5 m) with millimetric adjustment.</p> <p><b>1099317X</b> Cable cup with steel cable (1.5 m)</p> <p><b>1099378X</b> 3 poles electrical wire with cable cup and steel cable (1.5 m).</p> <p><b>1099347X</b> 5 poles electrical wire with cable cup and steel cable (1.5 m).</p>	<p><b>1099149X</b></p>  <p>Galvanized steel hidden linear joint.</p>	 <p>Angular module. See catalogue for correct code.</p> <p>A = 606mm</p>	

## INSTALLATION

1. Verify installation requirements.
2. Remove screen and LED module from luminaire body.
3. Assemble bodies with appropriate accessories.
4. Install fixtures.
5. Wire the fixture respecting indications.

### 1 RECESSED INSTALLATION

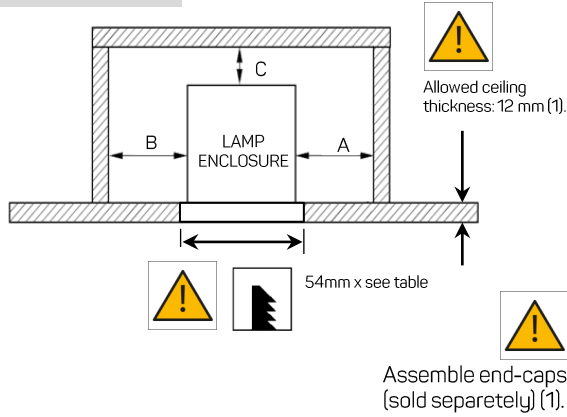

#### CLEARANCE

A	5 cm
B	5 cm
C	5 cm

#### FIXTURE

#### CUT-OUT

L=1123 mm	54 x L + 4 mm
L=1403 mm	54 x L + 4 mm
L=2246 mm	54 x L + 4 mm
L=2806 mm	54 x L + 4 mm



In case of multiple modules add +16 mm to the sum of the modules length. Ex. For two modules of 1123 mm each, the cut-out dimensions will be 2262 mm (2\*1123 mm + 16 mm) (2).

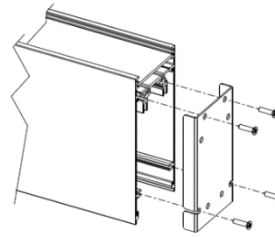

### SUSPENDED INSTALLATION

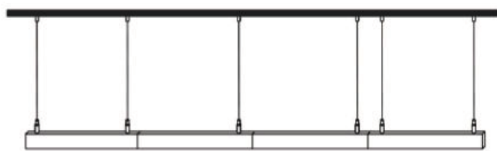

Total number of wire suspensions must always be at least N+1 (where N is the number of modules) (3)

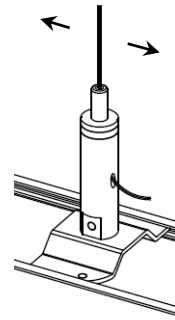

Sliding point (4).

### 2 Turn off power (1).

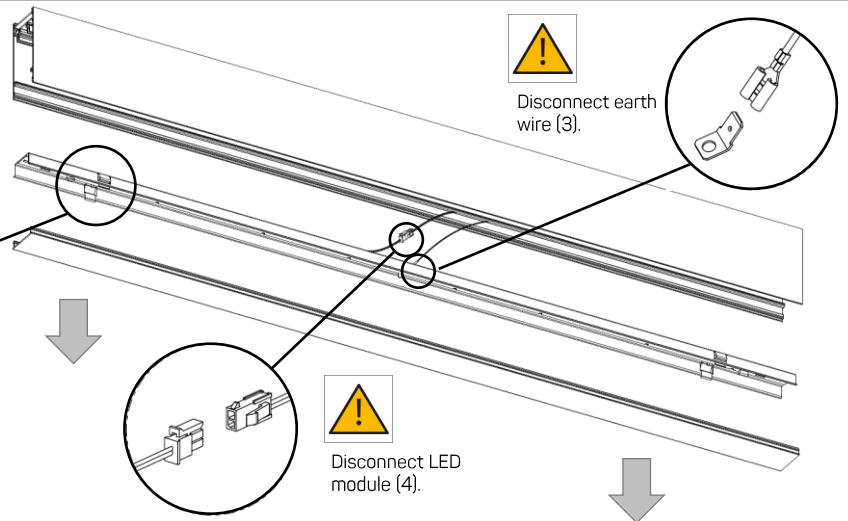
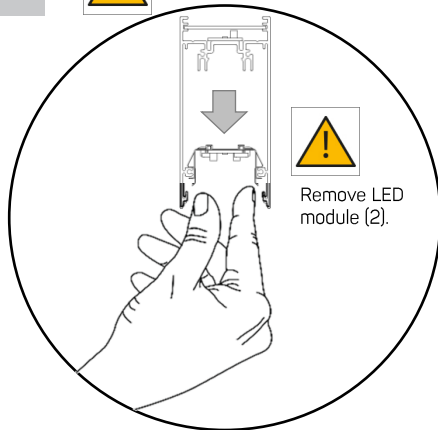

### 3 Assemble end-caps (sold separately) (1).

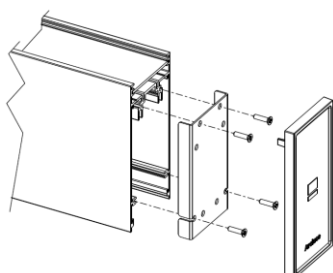

Install linear joint (2).

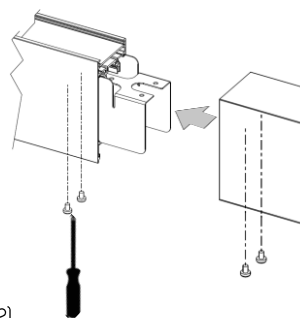

Wire the electrical bridge (3)

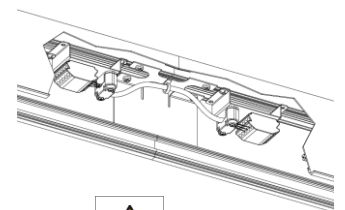

## 4

### RECESSED INSTALLATION

**A**

Secure bracket to false ceiling using appropriate screws and dowels (by others) (1)

**B**

Adjust fixture position to be flush with ceiling (2)

**C**

Apply plaster or silicon and finishing (3)

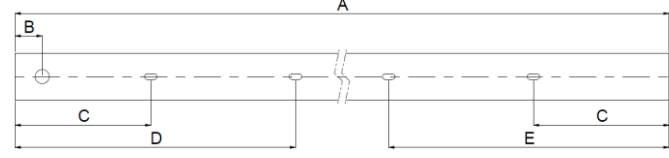

FIXTURE	A	B	C	D	E
L=1123 mm	1123	30	150		
L=1403 mm	1403	30	150		
L=2246 mm	2246	30	150		1123
L=2806 mm	2806	30	150	985	985

### SUSPENDED INSTALLATION

### CEILING INSTALLATION

Use only screws and dowels suitable for the mounting surface (by others) (4).

**A**

**B**

Data di emissione: 24.02.2020

Stato di modifica: M4

Codice: 6551110.11

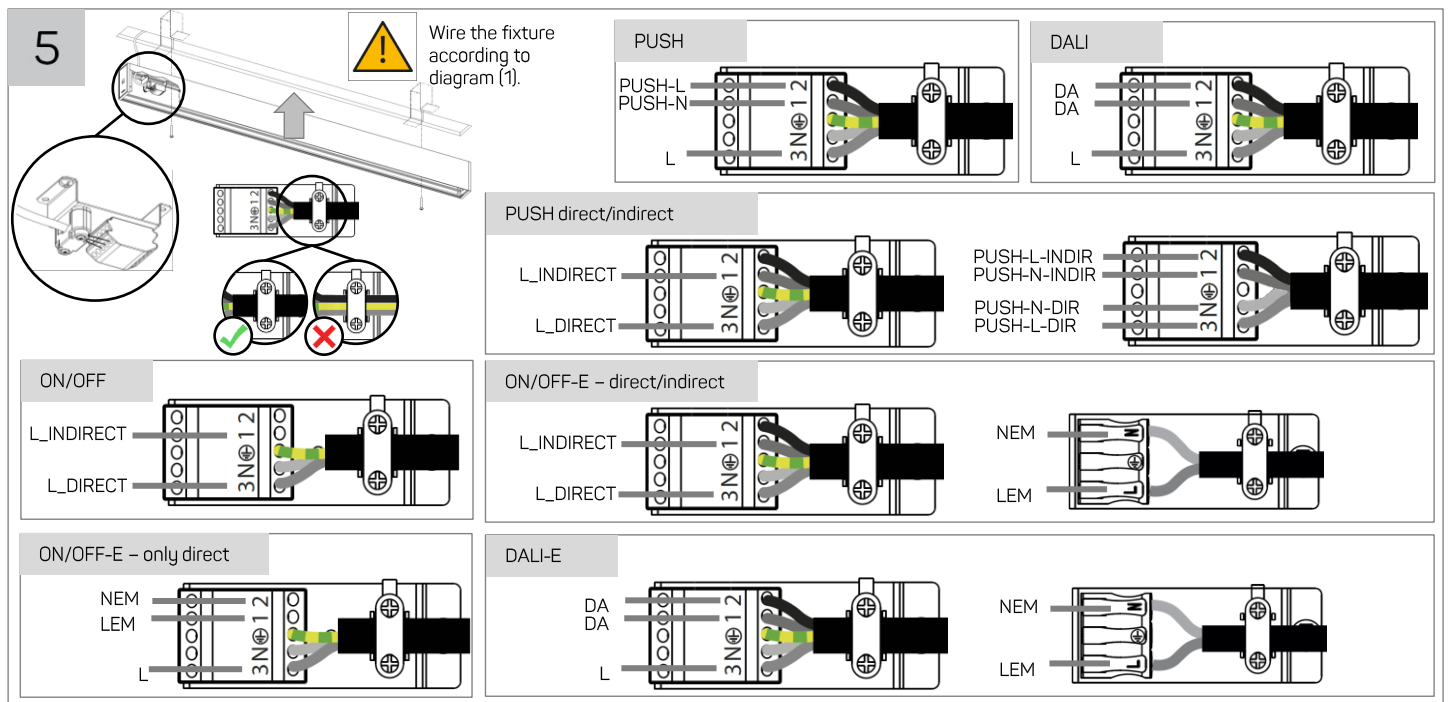

## AVERTISSEMENTS

### TOUTE MODIFICATION DE CET APPAREIL, SANS AUTORISATION, EST INTERDITE

Notre politique est l'amélioration constante du produit. Nous nous réservons le droit de modifier les caractéristiques de l'équipement sans préavis. Veuillez-vous référer au site web [www.arcluce.it](http://www.arcluce.it) pour cela et d'autres documents techniques continuellement mis à jour. Toutes les informations sont présentées de bonne foi, aucune responsabilité ne peut nous être imputée pour des erreurs, des omissions ou des interprétations incorrectes. Les photographies et les dessins sont dans les limites de la qualité de la reproduction imprimée, ils ne sont pas contraignants et à titre indicatif seulement.

Directive 2002/96/CE (Déchets d'Équipements Électriques et Électroniques - DEEE). L'étiquette de la poubelle à roulettes barrée indique que ce produit ne doit pas être éliminé comme les déchets urbains mais par une collecte séparée; ceci afin d'éviter des conséquences négatives potentielles sur l'environnement et la santé humaine.

Pour plus de détails sur les installations de collecte disponibles, veuillez contacter votre administration locale ou le revendeur auprès duquel ce produit a été acheté. La sécurité et le bon fonctionnement du luminaire sont garantis uniquement en respectant les normes électriques et les présentes instructions de montage; donc il est nécessaire de les garder. L'installation doit être effectuée par une personne qualifiée appropriée. Toujours se référer aux données électriques sur l'étiquette du luminaire la source lumineuse contenue dans ce luminaire ne doit être remplacée que par le fabricant, son agent de service ou une personne qualifiée similaire. N'utilisez que des pièces de rechange ARCLUCE.

(1) Avant toute intervention sur l'appareil éteindre l'alimentation. (2) Groupe à risque 1 (IEC/TR62778). Ne fixer pas la DEL en fonctionnement. (3) **Ne pas couvrir les appareils avec matériaux d'isolation thermique.**

### INSTALLATION:

1. Vérifiez les données d'installation. 2. Retirez l'écran et le module LED du corps du luminaire. 3. Assemblez les corps avec les accessoires appropriés. 4. Installez le luminaire. 5. Câbler le luminaire selon le schéma.

### IMAGES:

(1.1) Épaisseur de plafond autorisée. (1.2) En cas de modules multiples, ajoutez +12 mm à la somme de la longueur des modules. Ex. Pour deux modules de 1123 mm chacun, les dimensions de découpe seront de 2258 mm (2 \* 1123 mm + 12 mm). (1.3) Le nombre total de fils de suspensions doit toujours être d'au moins N + 1 (où N est le nombre de modules). (1.4) Point de fixation coulissant. (1.5) Point de fixation fixe. (2.1) Éteindre l'alimentation (2.2) Retirer le module LED (2.3) Débranchez le fil de terre (2.4) Débranchez le module LED (3.1) Assemblez les embouts (fournies séparément) (3.2) Installer le joint linéaire (3.3) Câblez la connexion traversante (4.1) Fixez les étriers au faux plafond en utilisant uniquement des vis et des chevilles adaptées à la surface de montage (par de tiers). (4.2) Ajustez la position du luminaire pour qu'il soit aligné avec le plafond. (4.3) Appliquez du plâtre ou du silicone et la finition. (4.4) Utilisez uniquement des vis et des chevilles adaptées à la surface de montage (par des tiers) (5.1) Câbler le luminaire selon le schéma.

## AVVERTENZE

### SONO VIETATE MODIFICHE ALL'APPARECCHIO SENZA AUTORIZZAZIONE

Perseguiamo una politica di costante miglioramento del prodotto. Ci riserviamo il diritto di modificare le caratteristiche dell'apparecchiatura senza preavviso. Si prega di fare riferimento al sito [www.arcluce.it](http://www.arcluce.it) per questo e altri documenti tecnici che vengono continuamente aggiornati. Tutte le informazioni sono presentate in buona fede. Nessuna responsabilità ci può essere attribuita per errori, omissioni o interpretazioni errate. Le fotografie e i disegni sono nei limiti della qualità della riproduzione stampata, non sono vincolanti e solo per informazione.

Direttiva 2002/96/CE (Rifiuti di Apparecchiature Elettriche ed Elettroniche - RAEE). Il pittogramma del bidone con ruote barrato indica che questo prodotto non deve essere smaltito come normale rifiuto urbano ma attraverso raccolta separata; questo per evitare potenziali conseguenze negative per l'ambiente e la salute umana. Per i dettagli sulle strutture di raccolta disponibili, contattare l'ufficio governativo locale o il rivenditore presso il quale è stato acquistato il prodotto.

La sicurezza e il corretto funzionamento dell'apparecchio sono garantiti solo rispettando le normative elettriche e queste istruzioni pertanto è necessario conservarle.

L'installazione deve essere eseguita da personale qualificato fare sempre riferimento ai dati elettrici presenti sull'etichetta dell'apparecchio. La sorgente luminosa contenuta in questo apparecchio deve essere sostituita solo dal costruttore o dal suo servizio di assistenza o da personale altrettanto qualificato. Utilizzare solamente pezzi di ricambio originali ARCLUCE.

(1) Prima di qualsiasi intervento sul dispositivo, spegnere l'alimentazione. (2) Gruppo di rischio 1 (IEC/TR62778). Non fissare il LED durante il suo funzionamento. (3) **Apparecchio non idonei ad essere ricoperti di materiale termicamente isolante.**

### INSTALLAZIONE

1. Verificare i vincoli d'installazione. 2. Rimuovere lo schermo e il modulo LED dal corpo dell'apparecchio. 3. Assemblare i corpi con gli accessori adeguati. 4. Installare l'apparecchio. 5. Cablare l'apparecchio seguendo lo schema.

### IMMAGINI

(1.1) Spessore del soffitto consentito. (1.2) Nel caso di più moduli aggiungere +12 mm alla somma della lunghezza dei moduli. Ex. Per due moduli di 1123 mm ciascuno, le dimensioni del ritaglio saranno 2258 mm (2 \* 1123 mm + 12 mm). (1.3) Il numero totale di cavi di sospensione deve essere sempre almeno N + 1 (dove N è il numero di moduli). (1.4) Punto di fissaggio scorrevole. (1.5) Punto di fissaggio fisso. (2.1) Spegner l'alimentazione. (2.2) Rimuovere il modulo LED (2.3) Scollegare il filo di terra (2.4) Scollegare il modulo LED. (3.1) Assemblare le testate (fornite separatamente) (3.2) Installare il giunto lineare (3.3) Cablare il collegamento passante. (4.1) Installare le staffe nel controsoffitto utilizzando solo viti e tasselli adatti alla superficie di montaggio (da terzi). (4.2) Regolare la posizione dell'apparecchio in modo che sia a filo del soffitto. (4.3) Applicare intonaco o silicone e la finitura. (4.4) Utilizzare solo viti e tasselli adatti alla superficie di montaggio (da terzi). (5.1) Cablare l'apparecchio seguendo lo schema.